

RUBICON

L'infrastructure de l'échangeur Échangeur Turcot de Montréal

Rendu du 17 Juin 2021

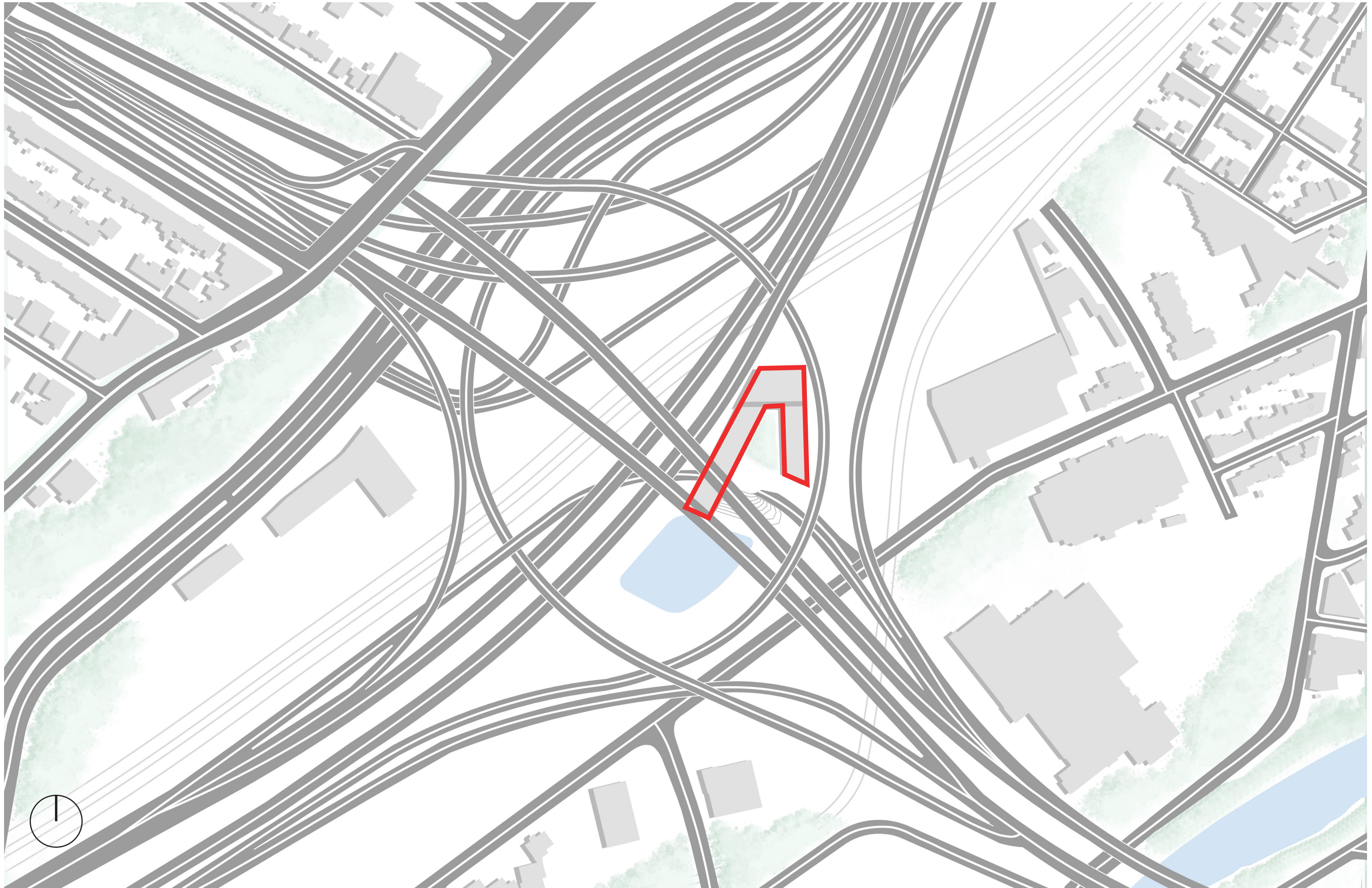



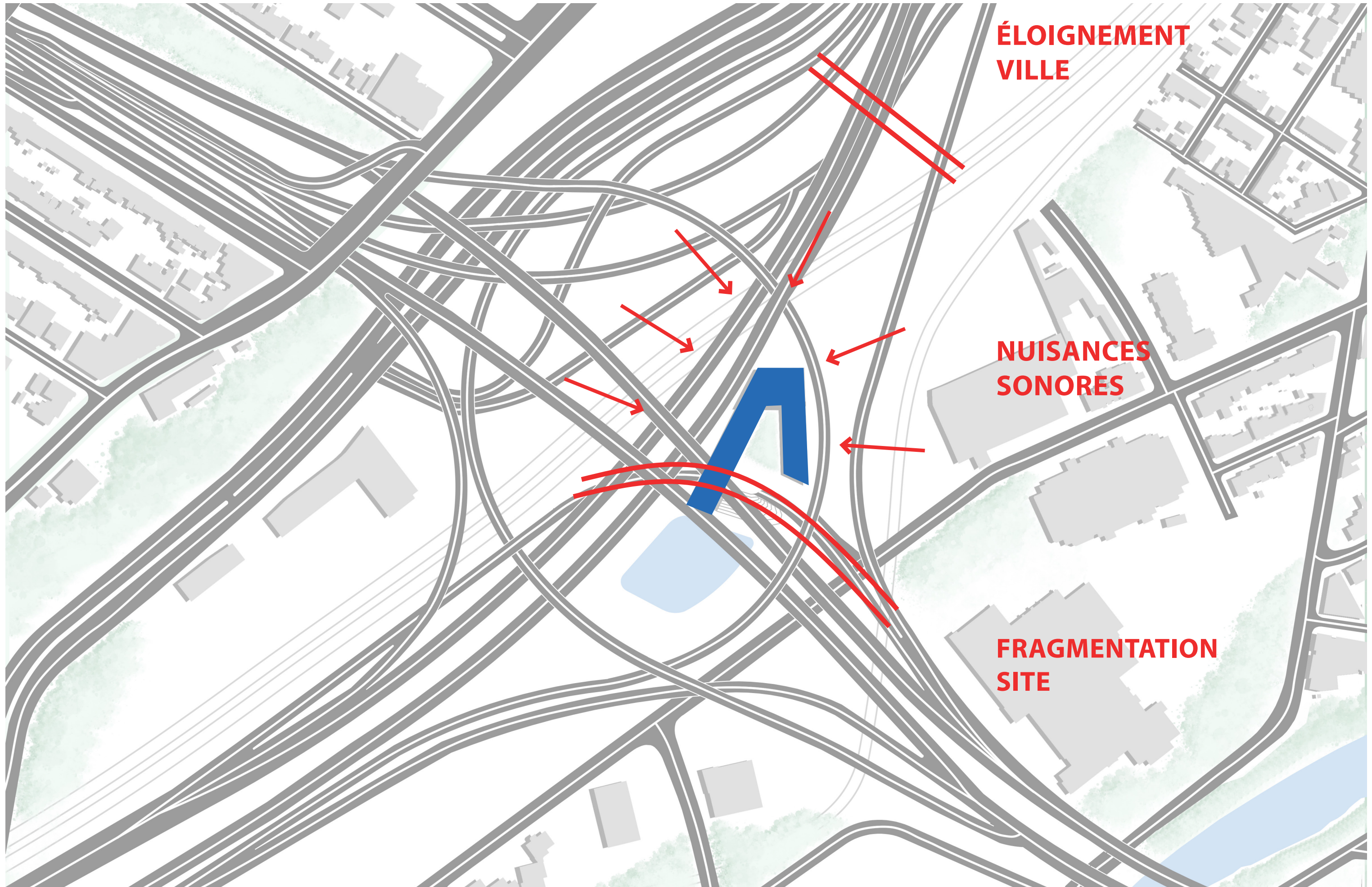

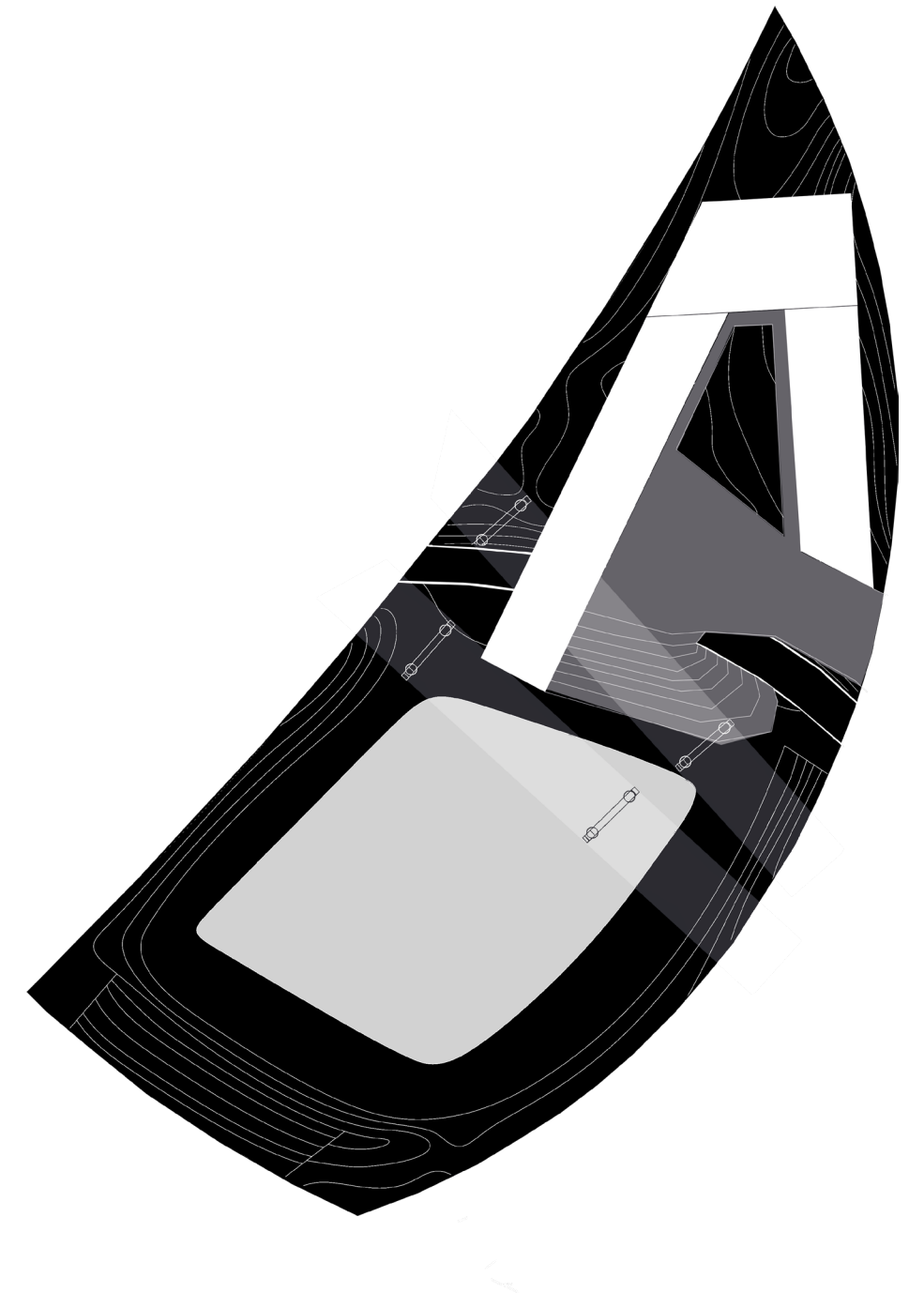
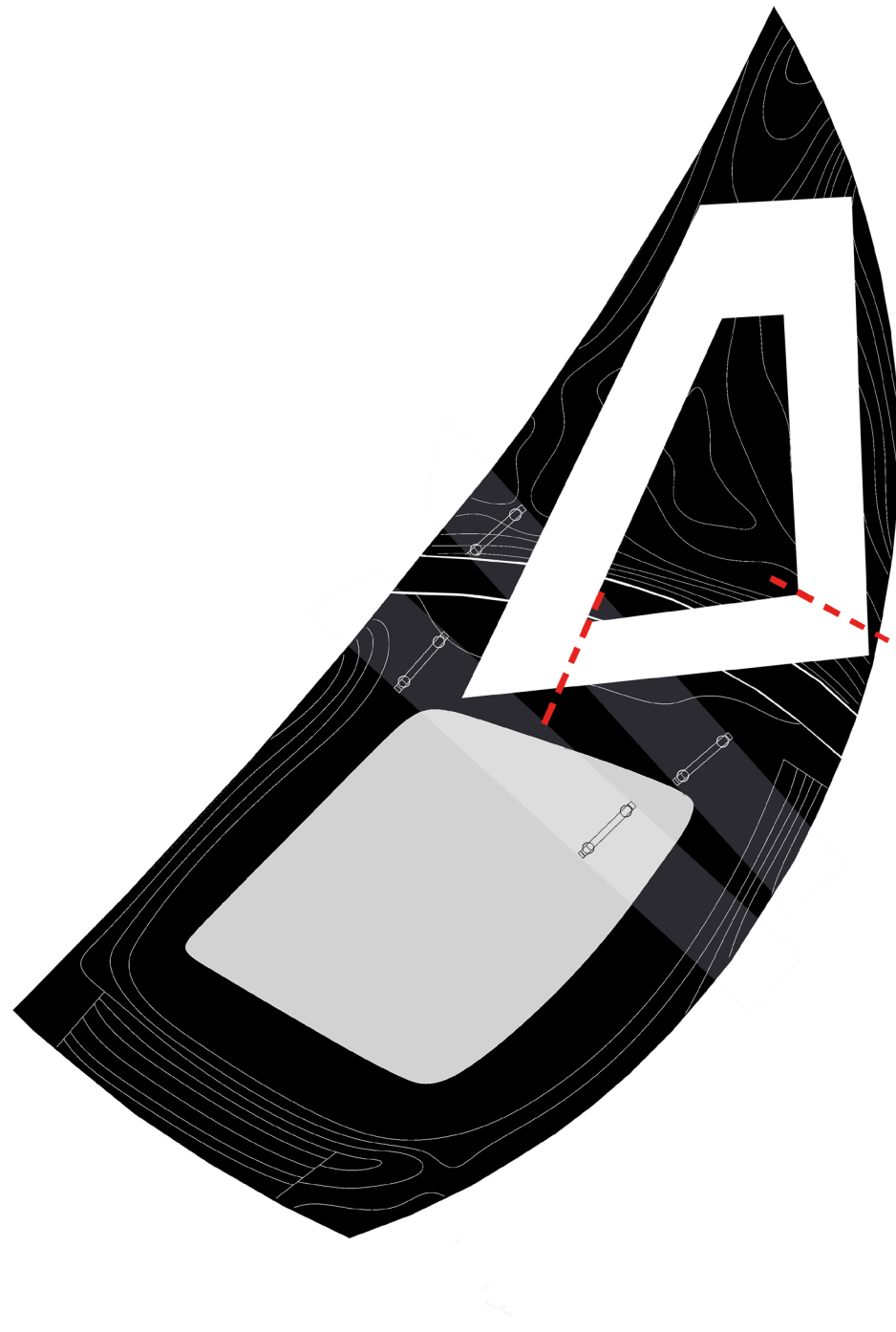
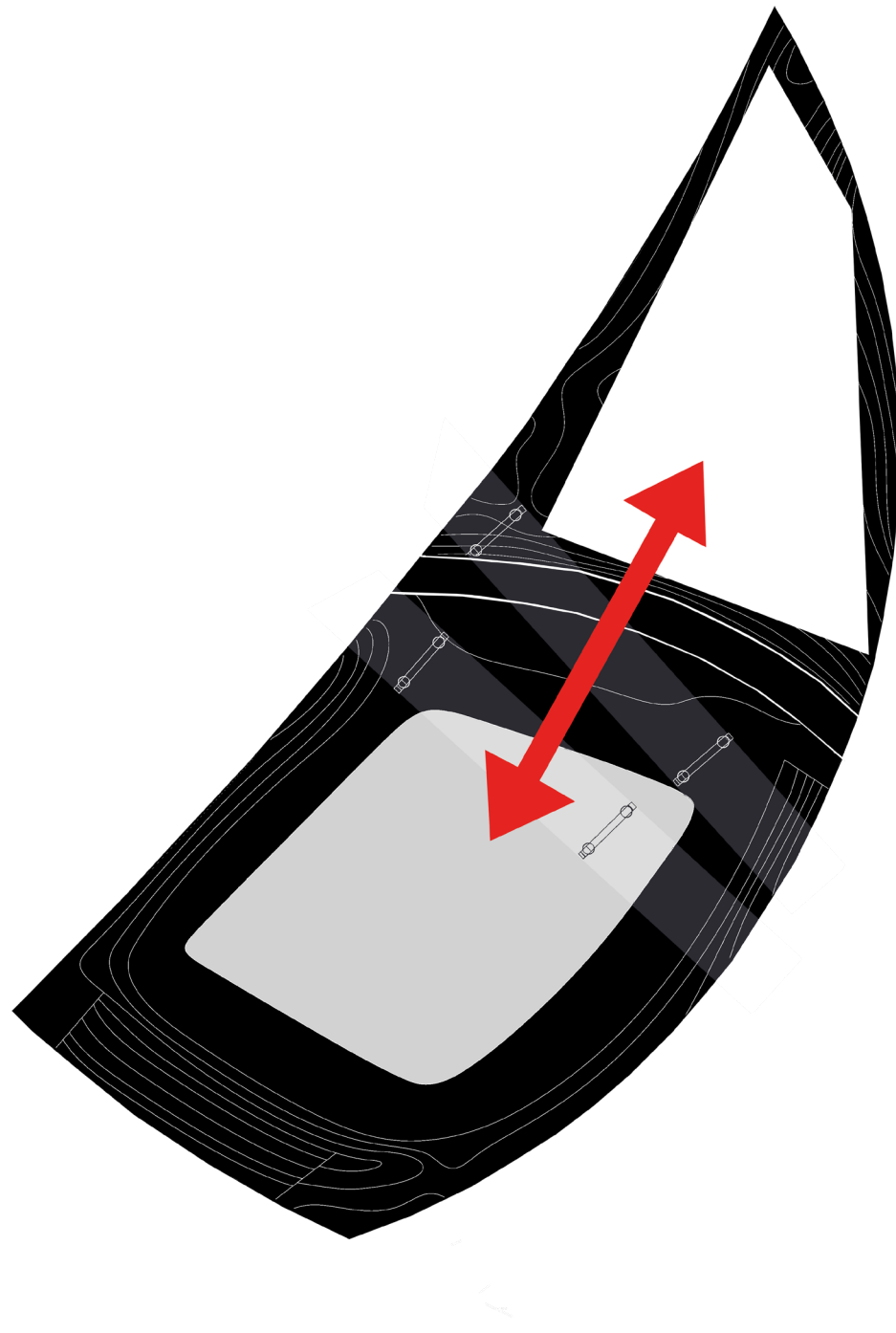

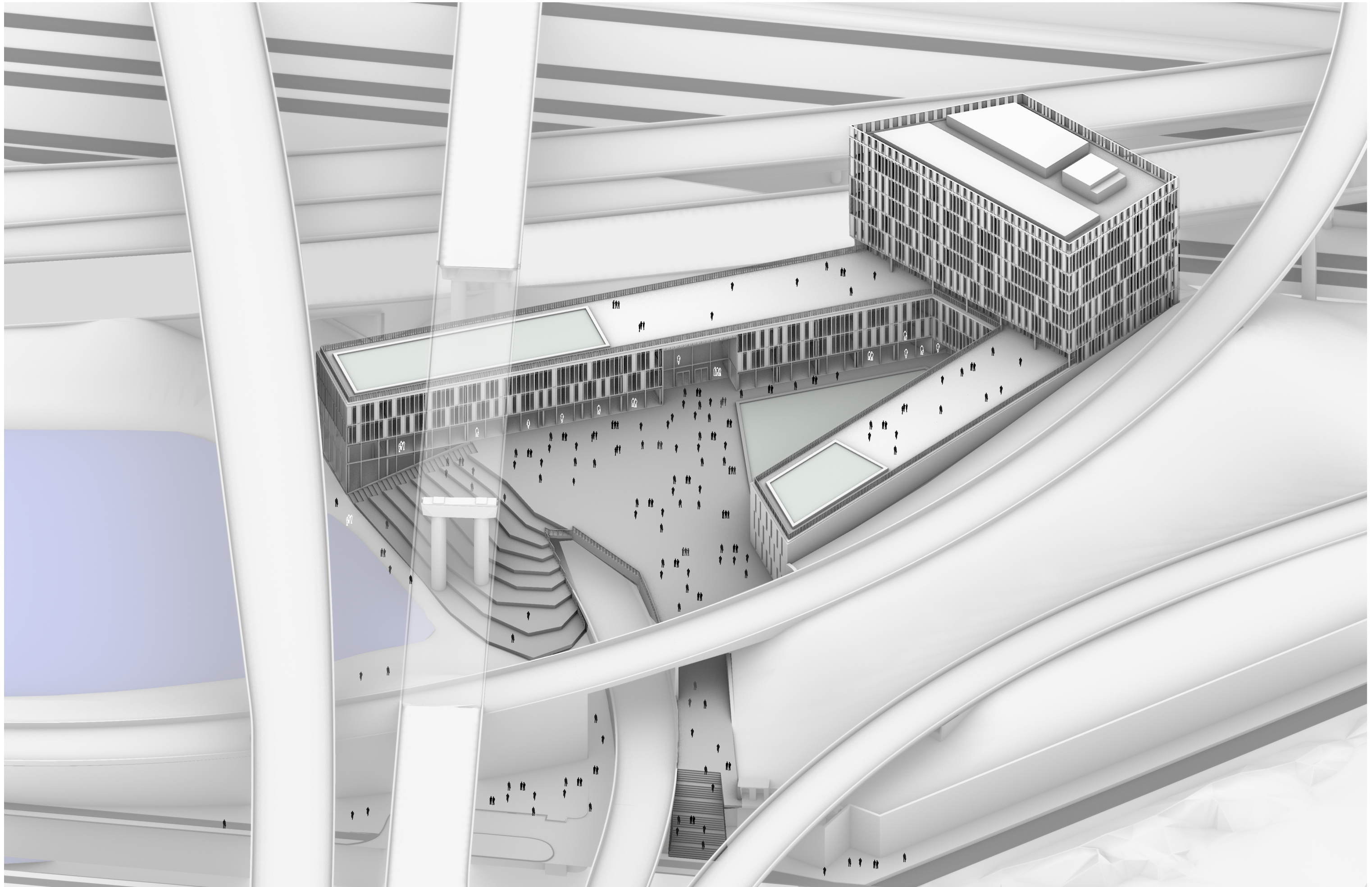





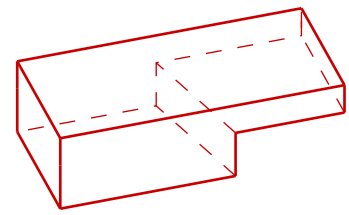

RESTAURANT
600 M²

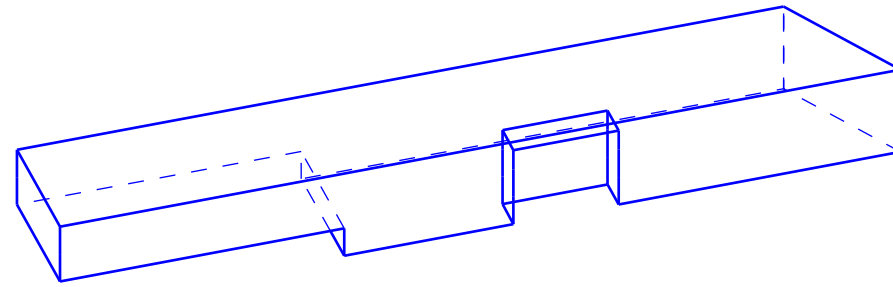

ÉCOLE DE CUISINE
3100 M²

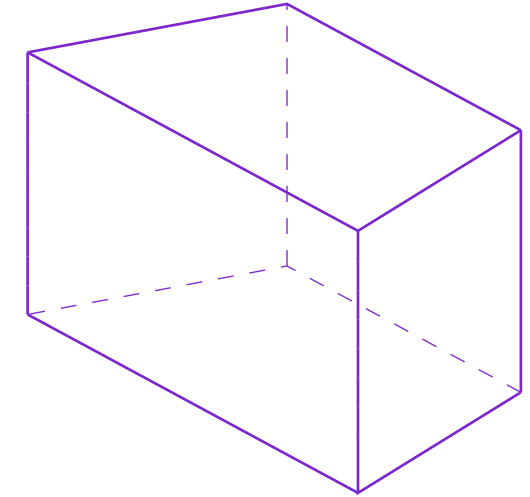

BUREAUX
9000 M²

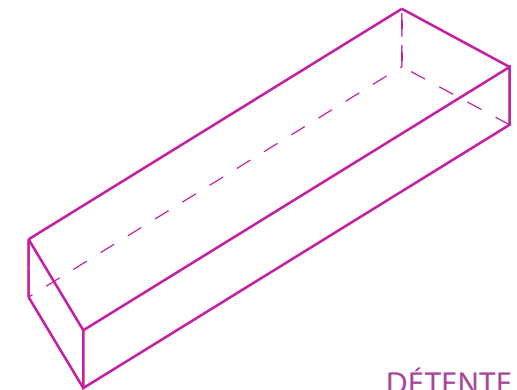
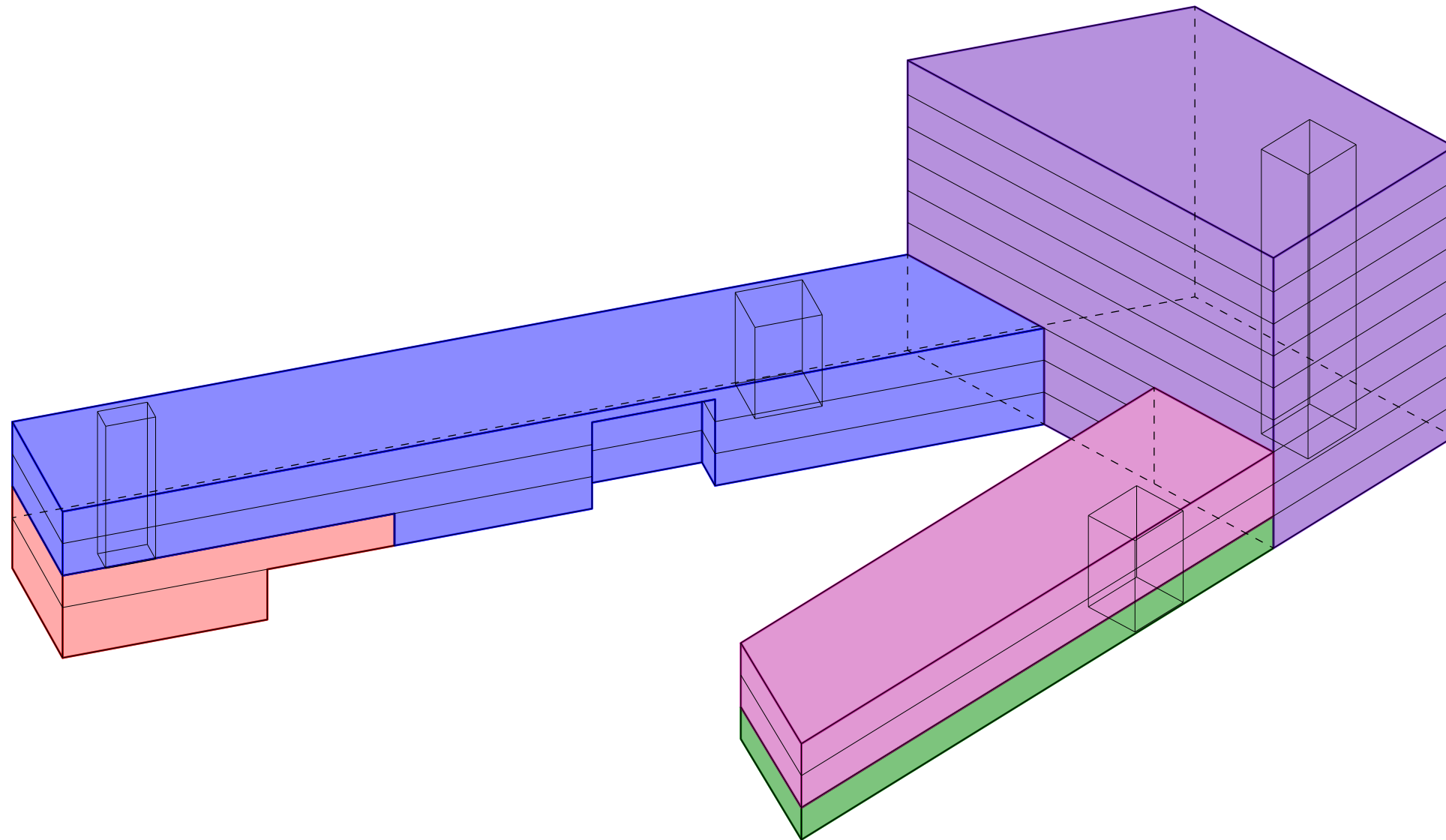

DÉTENTE
1700 M²

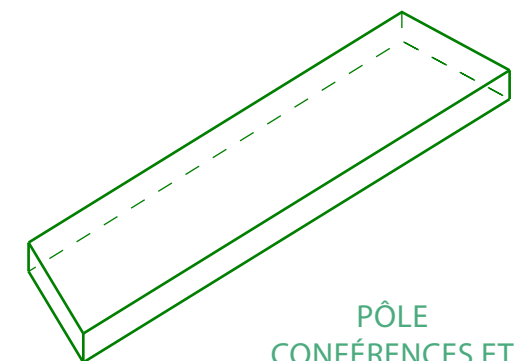

PÔLE
CONFÉRENCES ET
ÉVÉNEMENTS
850 M²

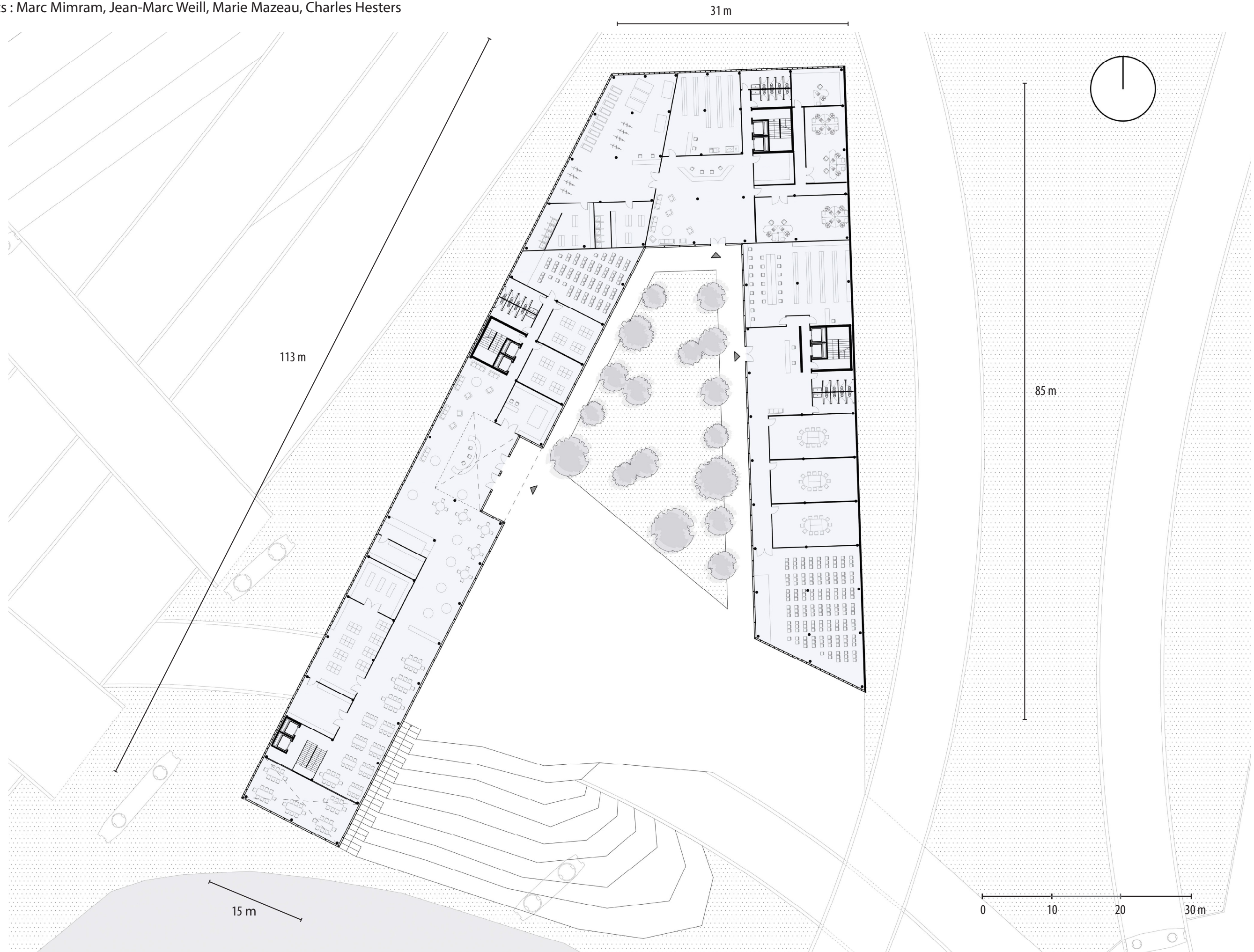



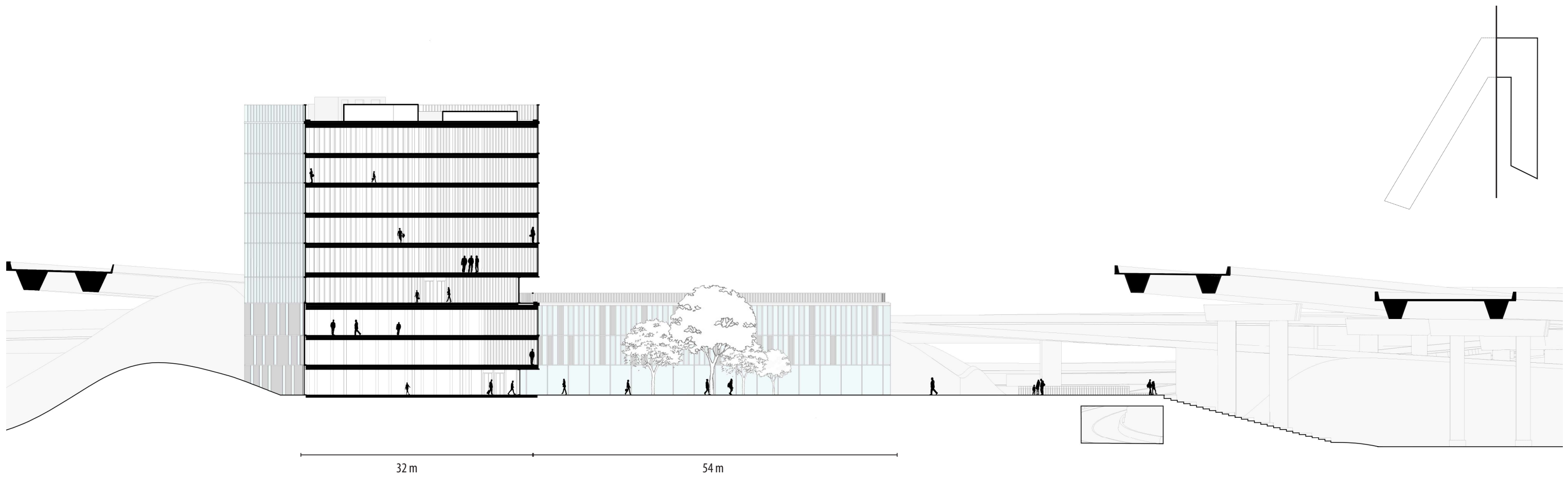
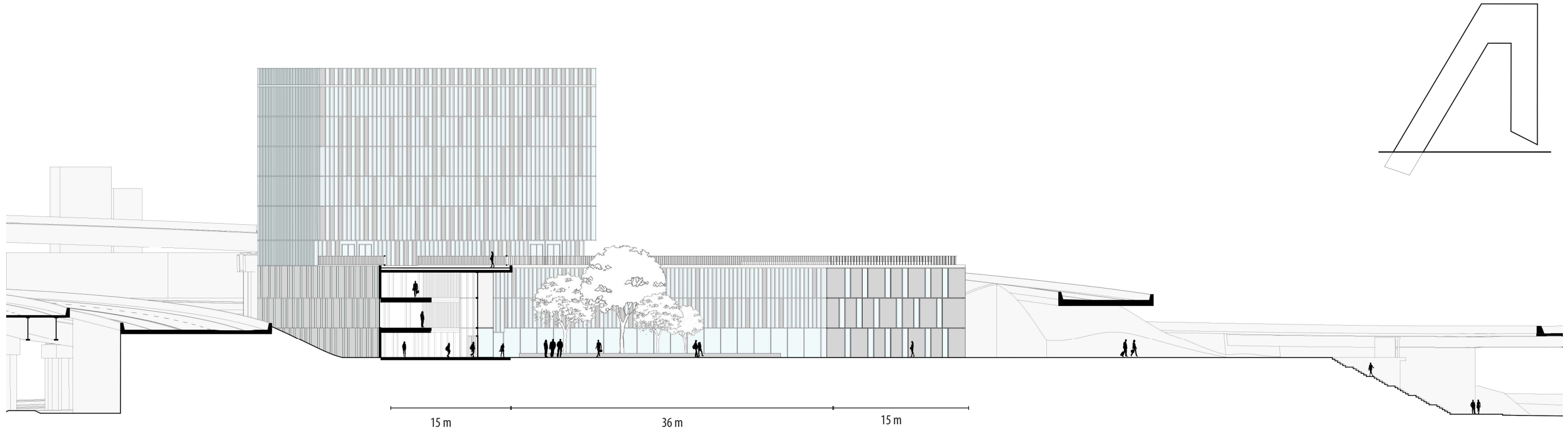

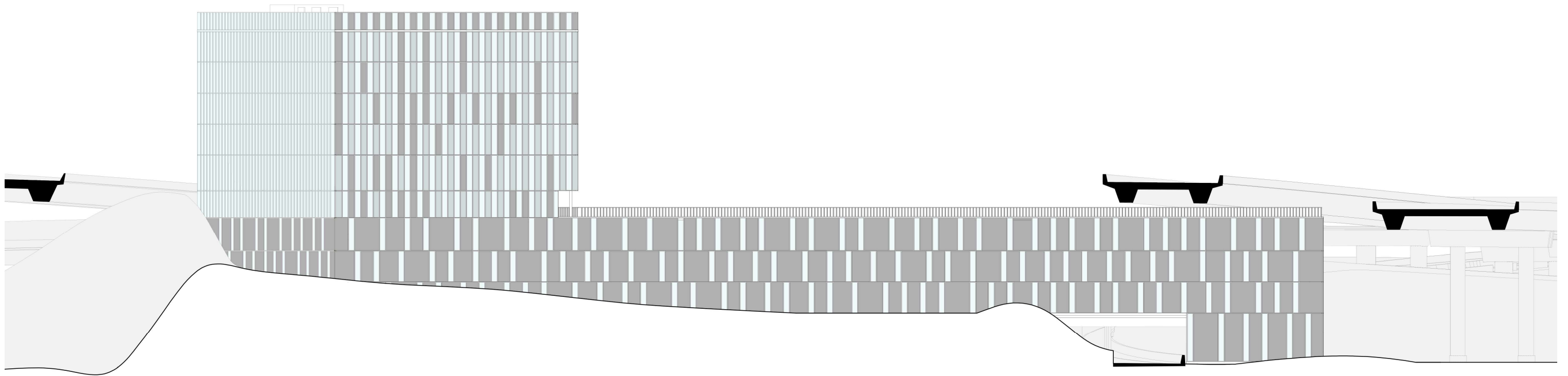
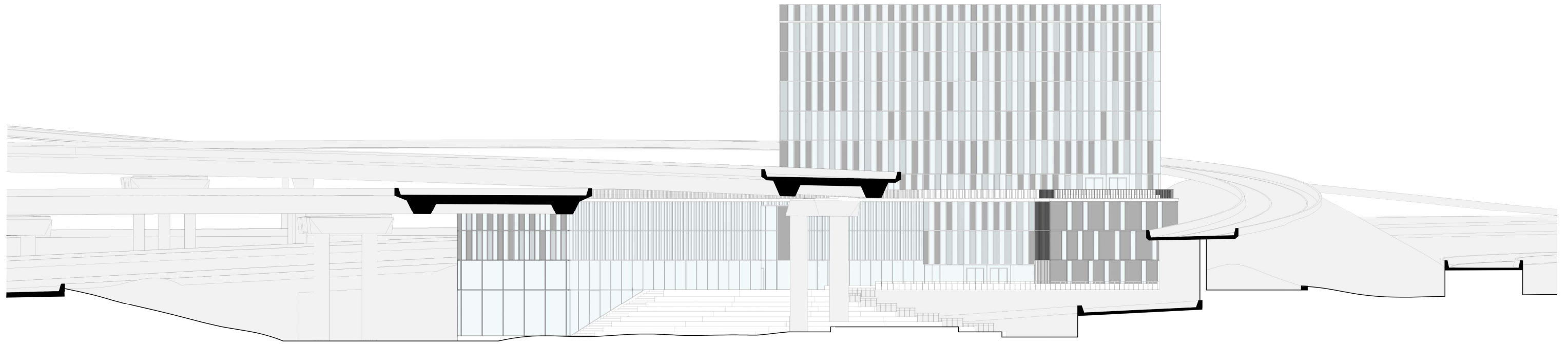



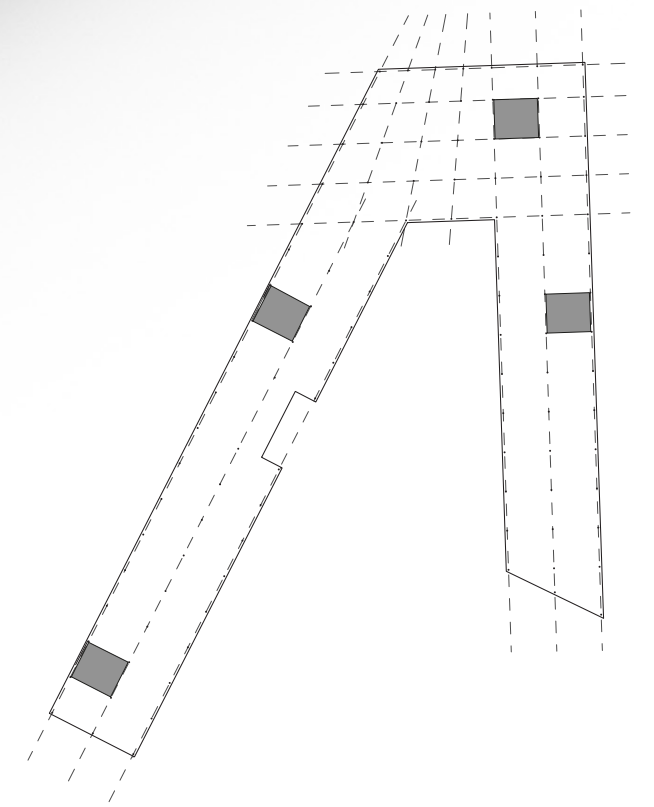
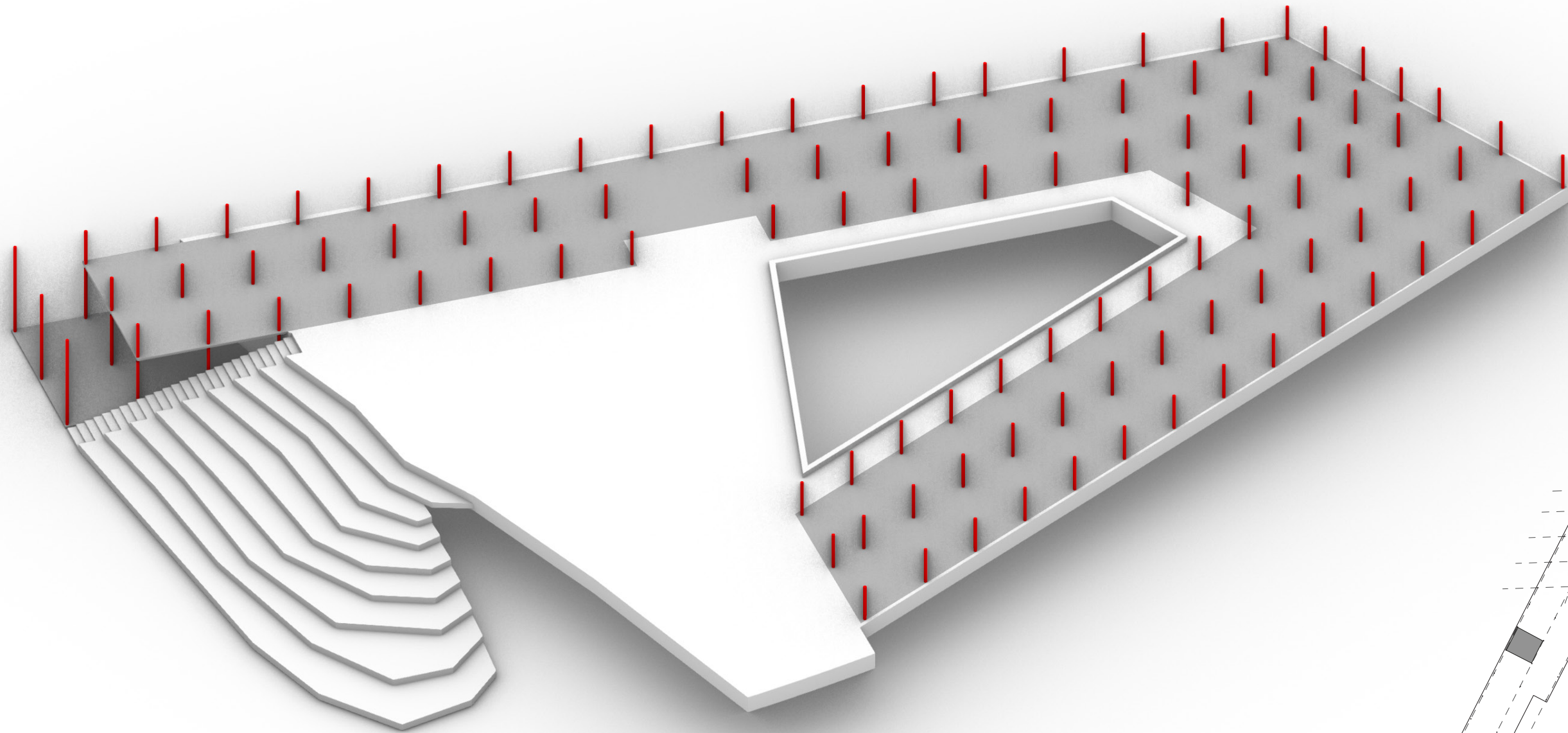

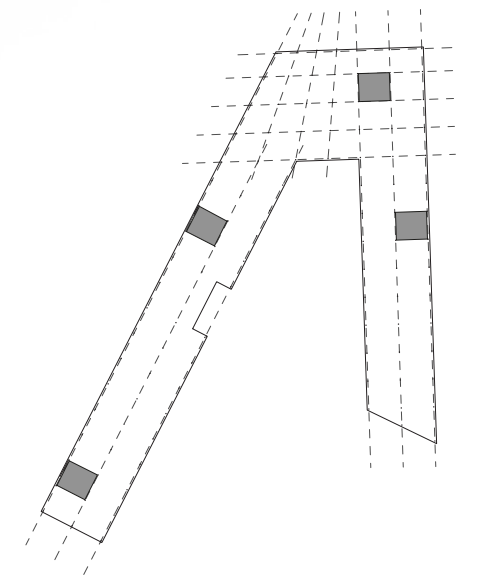
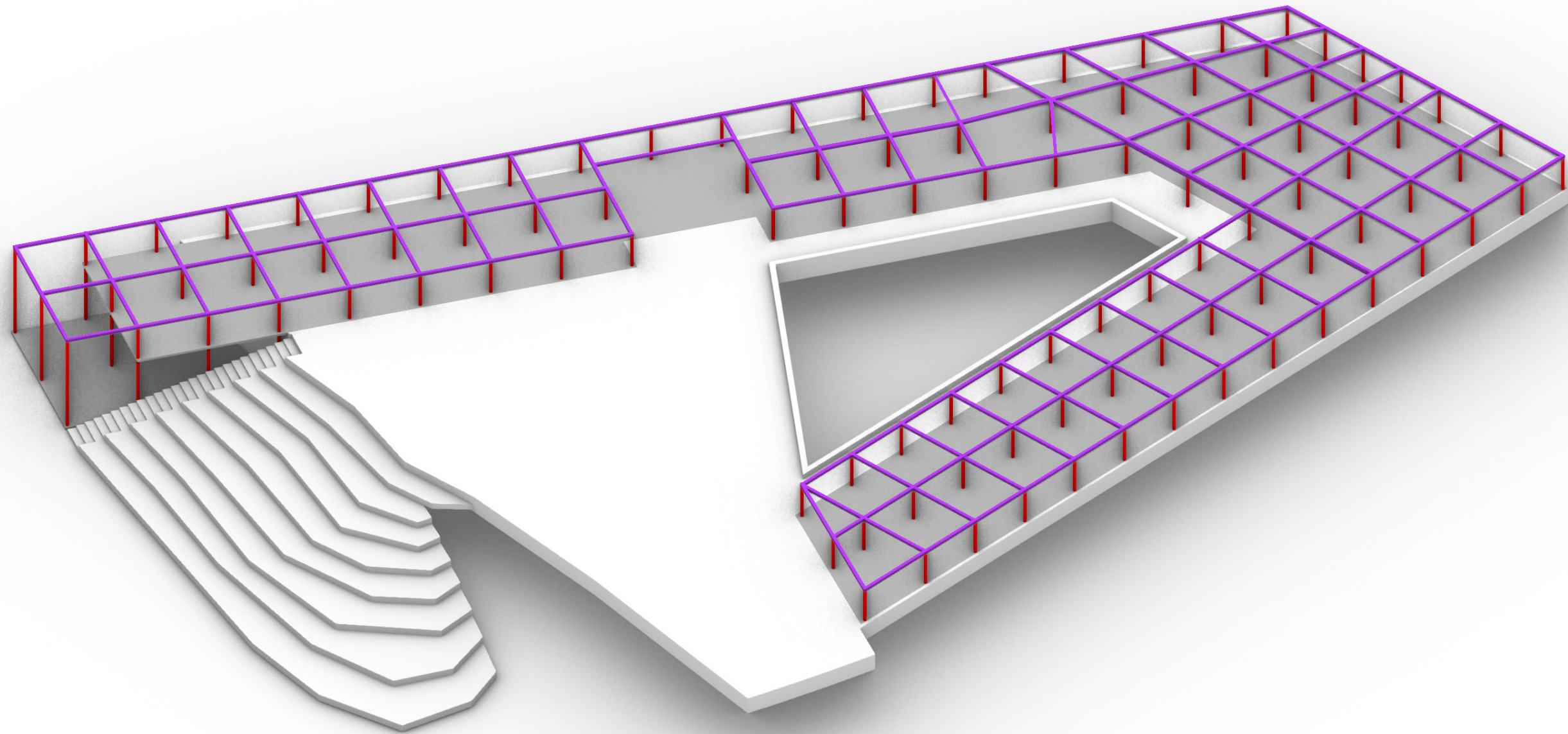

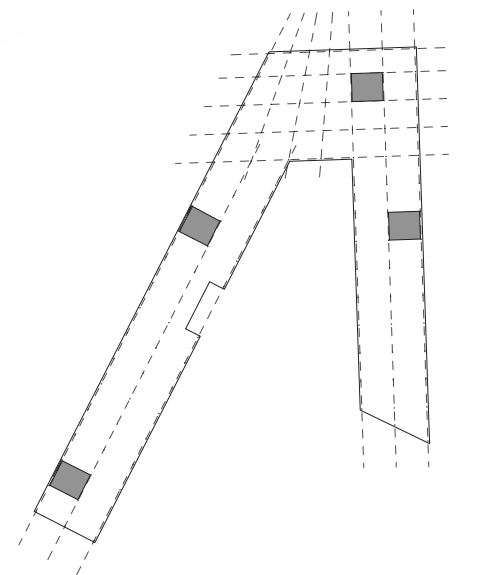
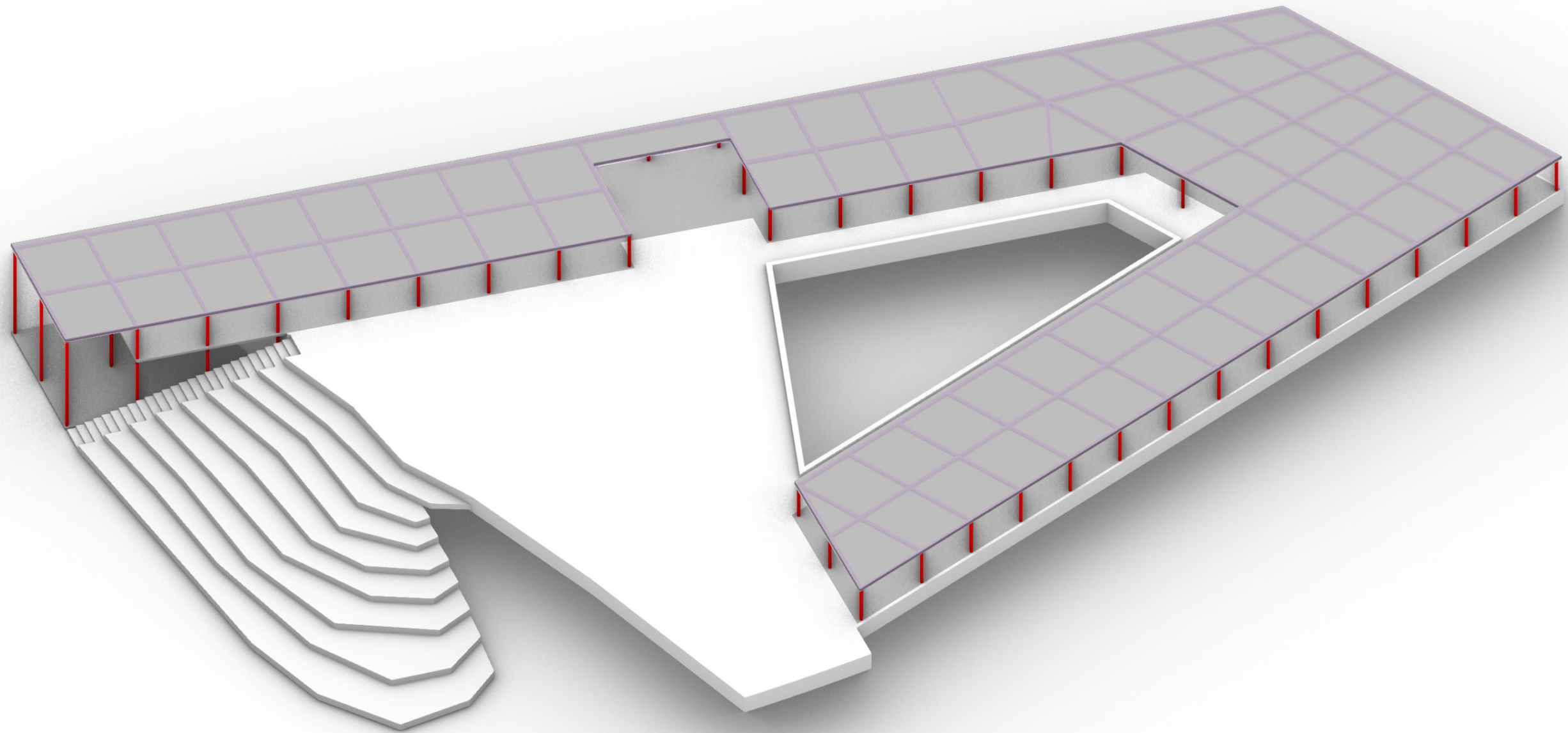

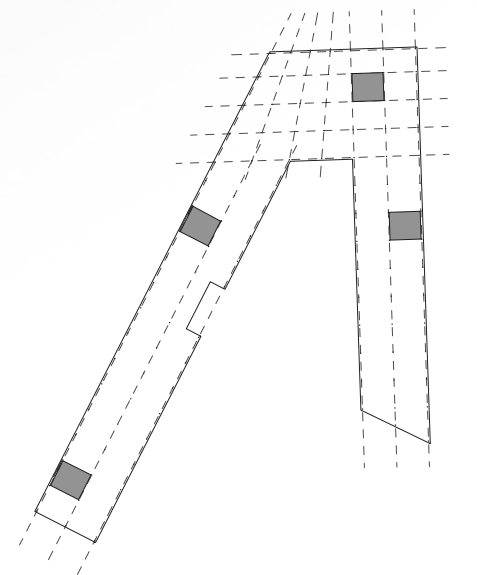
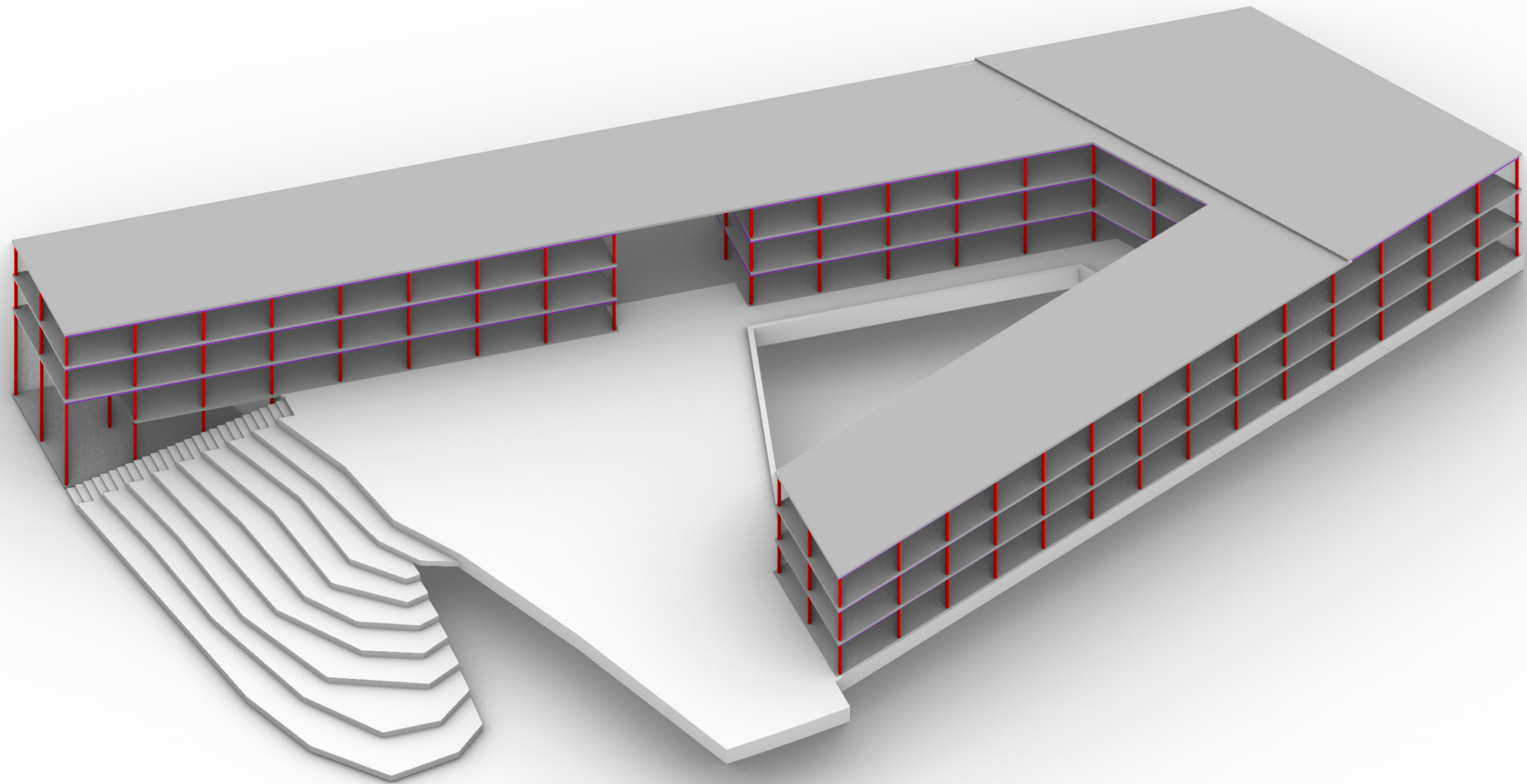

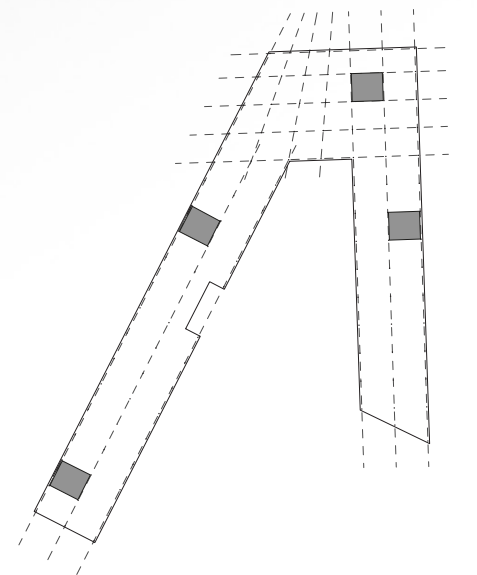
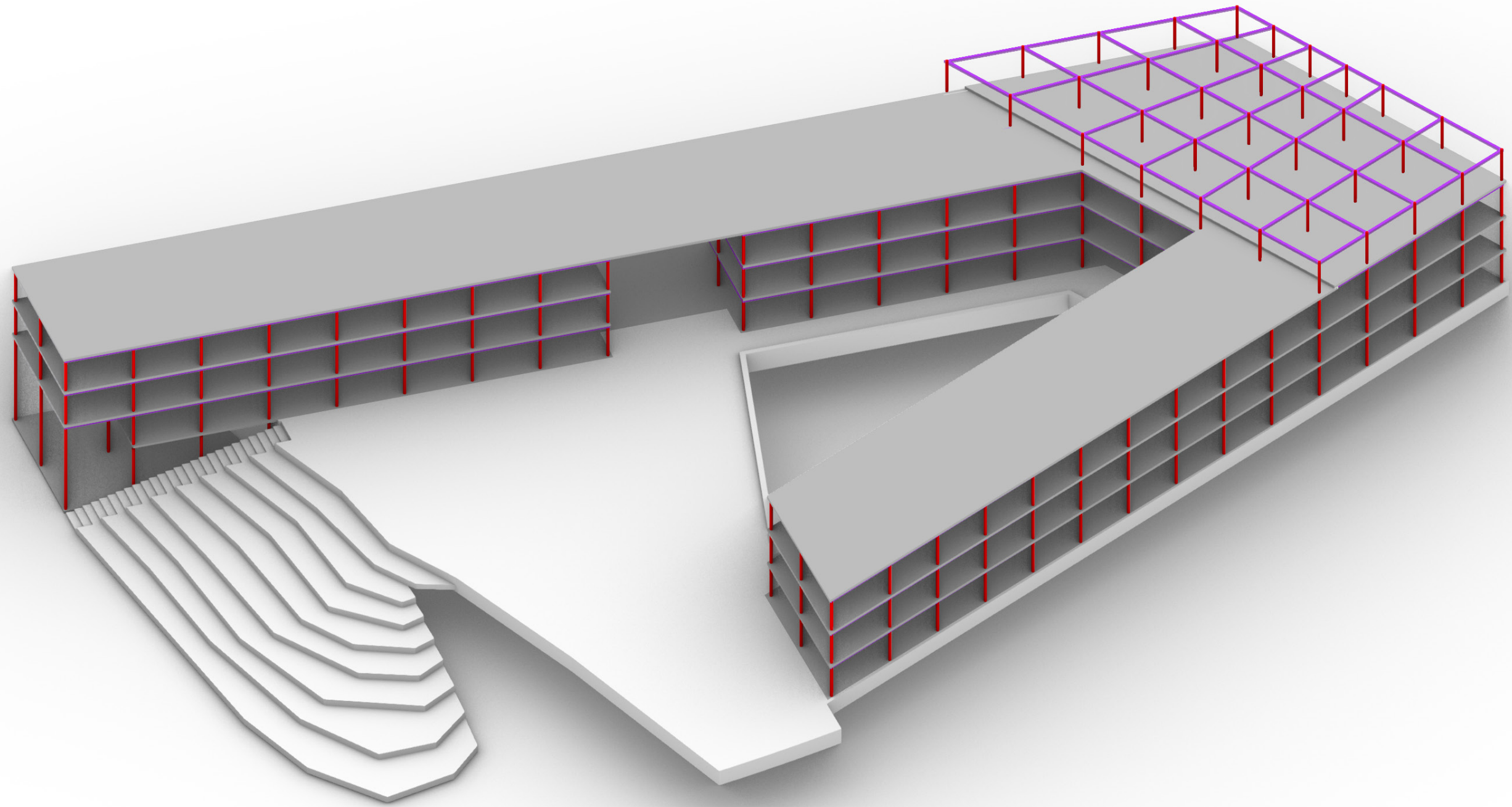

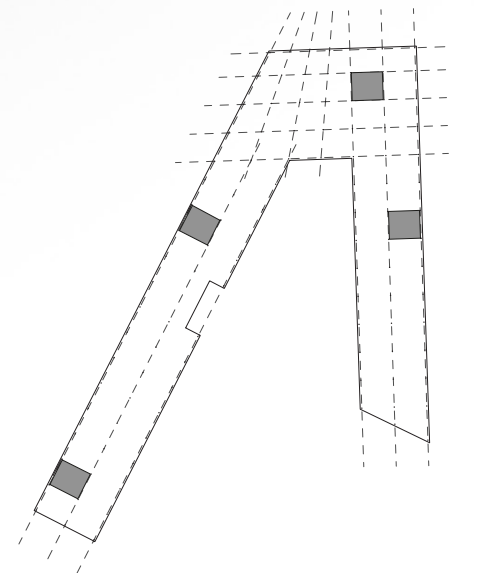
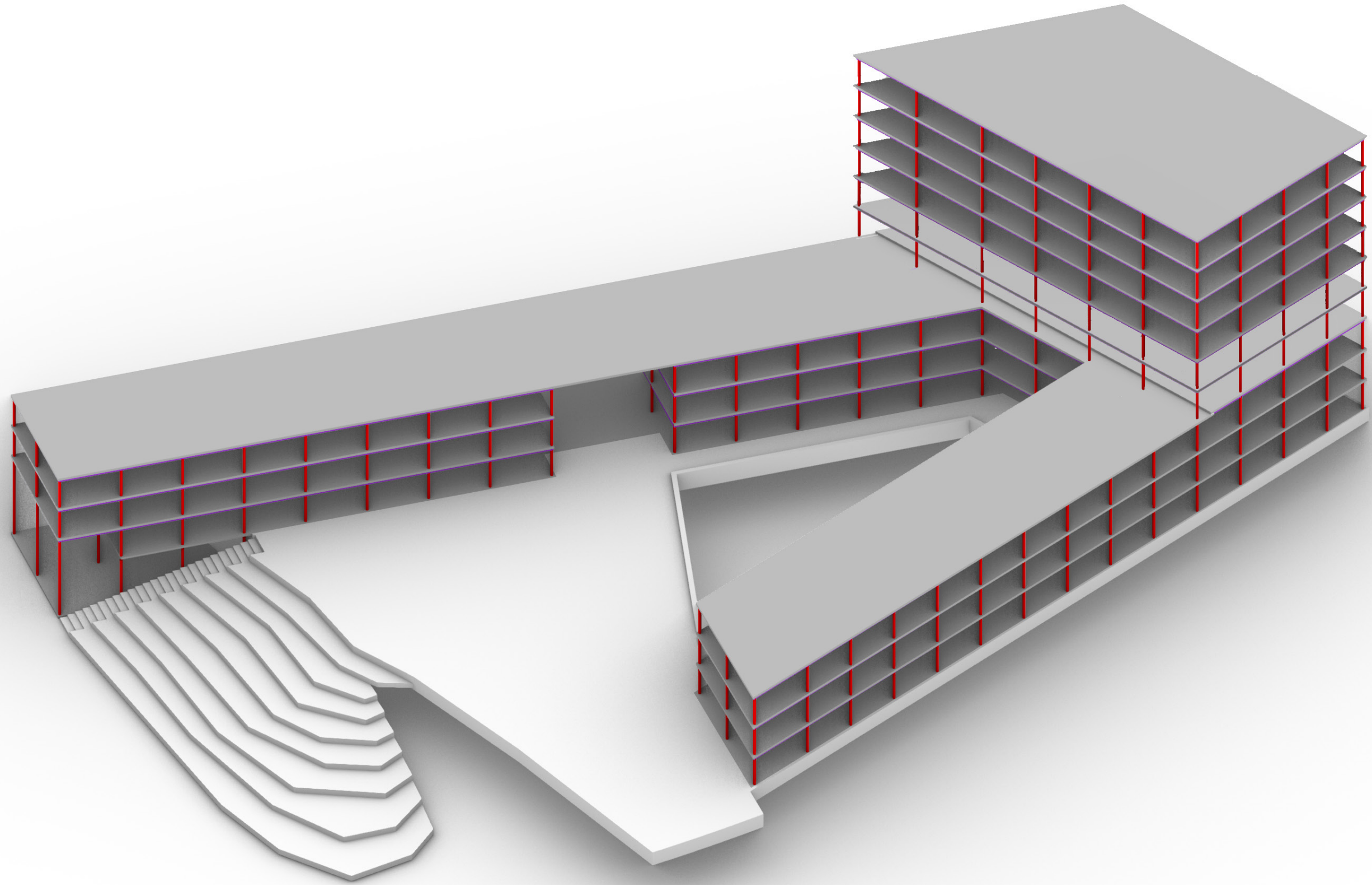

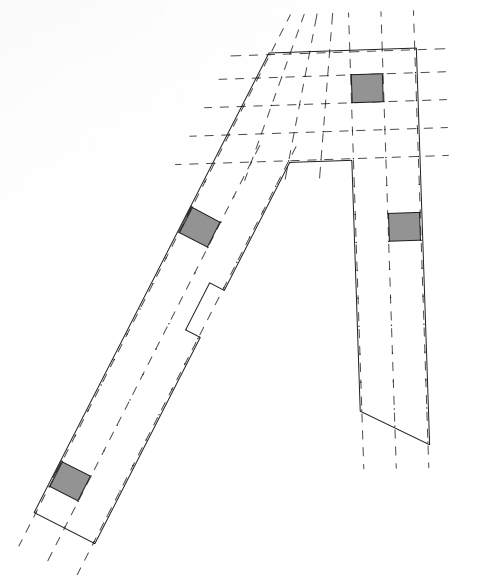
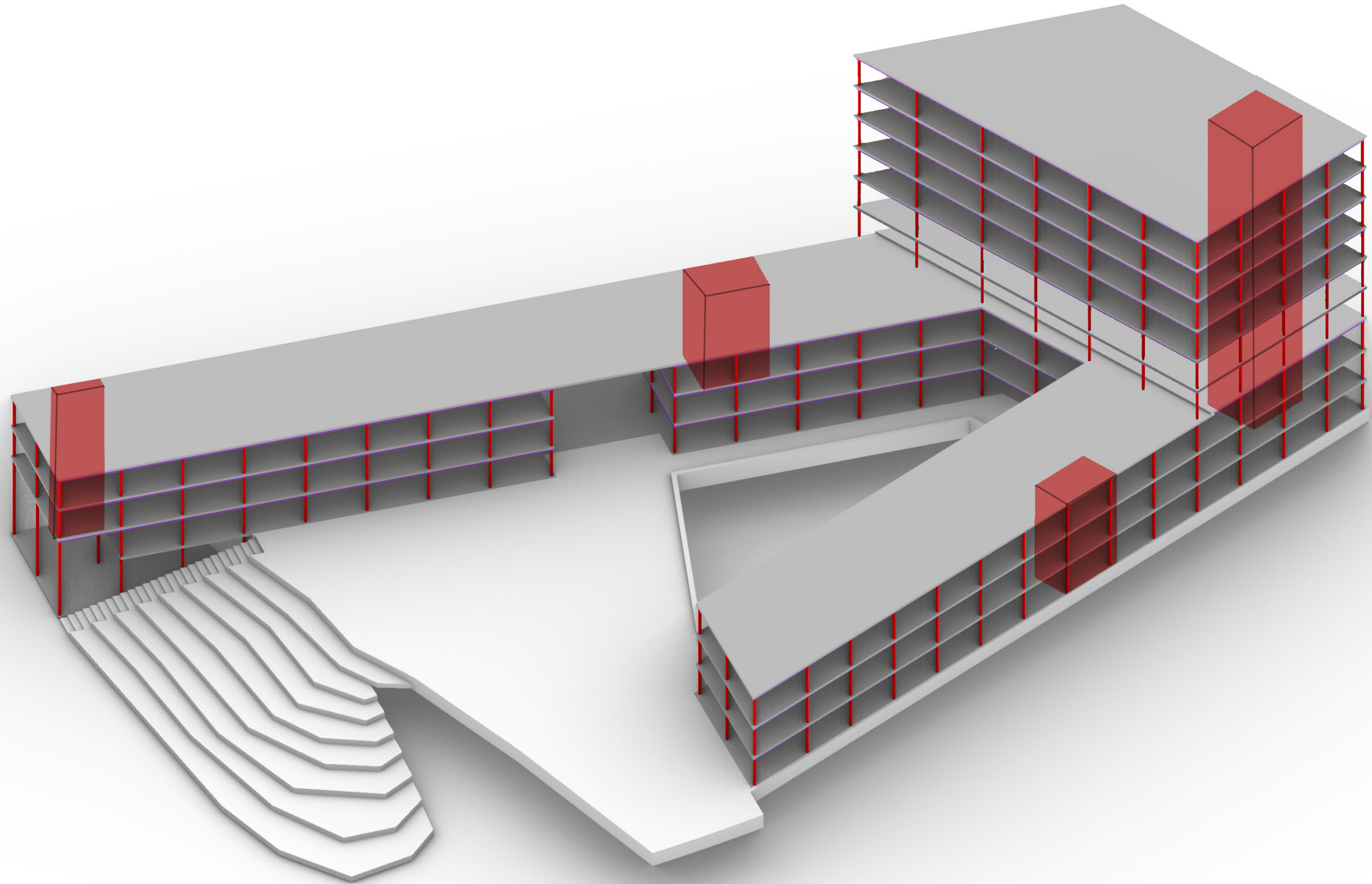



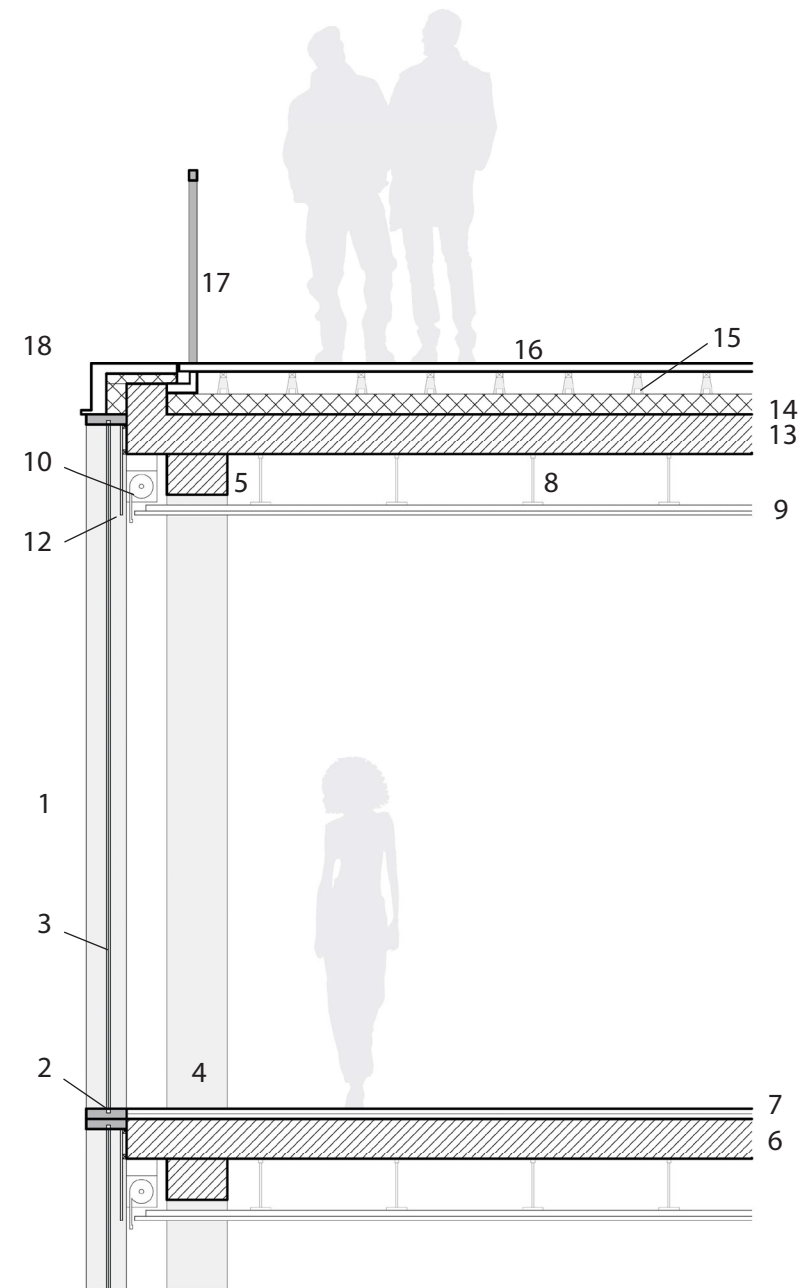

- I. Cadre Vitré
- II. Cadre Vitré avec Brise Soleil
- III. Cadre Plein avec ouvrant
- IV. Cadre Plein

- 1. Cadre Aluminium
- 2. Menuiserie Aluminium
- 3. Double Vitrage
- 4. Poteau
- 5. Poutre
- 6. Dalle béton
- 7. Revêtement du plancher
- 8. Suspension et rail métallique
- 9. Dalle de Faux-Plafond
- 10. Store, protection solaire
- 11. Brise Soleil
- 12. Cache Dalle
- 13. Isolation
- 14. Etanchéité
- 15. Plot
- 16. Dalle sur plots
- 17. Garde-corps à l'anglaise
- 18. Couvertine

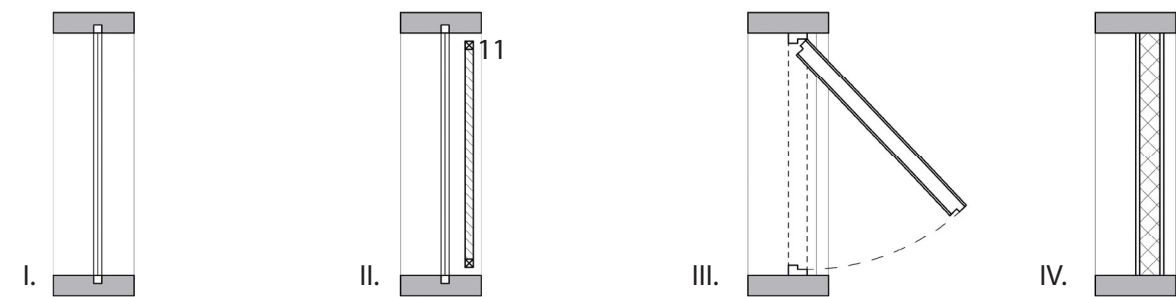

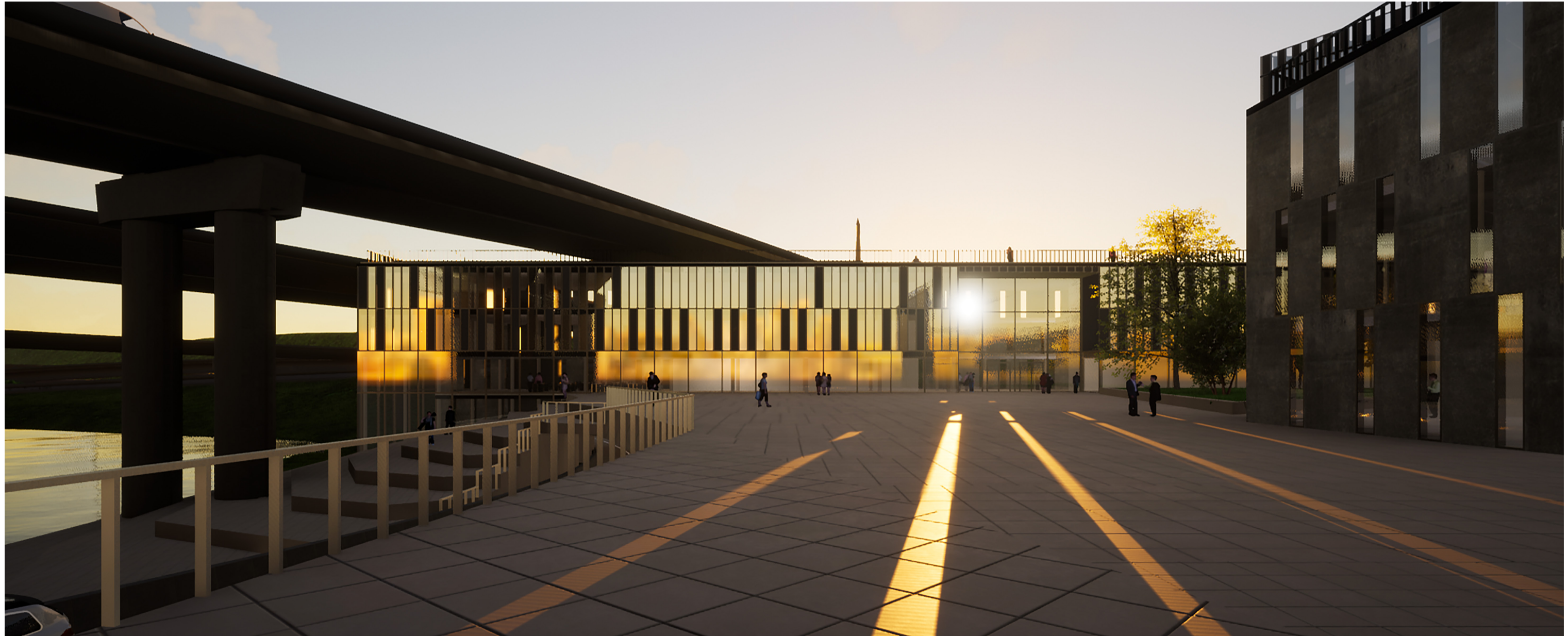

MERCI !

